

Modulating damper actuator for adjusting dampers in technical building installations

- Air damper size up to approx. 0.4 m²
- Torque motor 2 Nm
- Nominal voltage AC/DC 24 V
- Control modulating 2...10 V
- Position feedback 2...10 V
- Degree of protection IP66 - Optimum protection in smallest size

Technical data

| | | |
|------------------------|------------------------------------|---|
| Electrical data | Nominal voltage | AC/DC 24 V |
| | Nominal voltage frequency | 50/60 Hz |
| | Nominal voltage range | AC 19.2...28.8 V / DC 19.2...28.8 V |
| | Power consumption in operation | 1 W |
| | Power consumption in rest position | 0.5 W |
| | Power consumption for wire sizing | 1.5 VA |
| | Connection supply / control | Cable 1 m, 4x 0.75 mm ² |
| | Parallel operation | Yes (note the performance data) |
| Functional data | Torque motor | 2 Nm |
| | Operating range Y | 2...10 V |
| | Input impedance | 100 kΩ |
| | Position feedback U | 2...10 V |
| | Position feedback U note | Max. 1 mA |
| | Position accuracy | ±5% |
| | Direction of motion motor | counter-clockwise rotation |
| | Direction of motion note | Y = 0 V: left end stop, position 0 |
| | Manual override | with magnet |
| | Angle of rotation | 95°, fixed setting |
| | Running time motor | 75 s / 90° |
| | Sound power level, motor | 35 dB(A) |
| | Mechanical interface | Universal shaft clamp 6...12.7 mm |
| | Position indication | Mechanical, pluggable (with integrated magnet for gear train disengagement) |
| Safety data | Protection class IEC/EN | III, Safety Extra-Low Voltage (SELV) |
| | Power source UL | Class 2 Supply |
| | Degree of protection IEC/EN | IP66 |
| | Degree of protection NEMA/UL | NEMA 2 |
| | Enclosure | UL Enclosure Type 2 |
| | EMC | CE according to 2014/30/EU |
| | Certification IEC/EN | IEC/EN 60730-1 and IEC/EN 60730-2-14 |
| | UL Approval | cULus according to UL60730-1A, UL60730-2-14 and CAN/CSA E60730-1 The UL marking on the actuator depends on the production site, the device is UL-compliant in any case |
| | Hygiene test | According to VDI 6022 Part 1 / SWKI VA 104-01, cleanable and disinfectable, low emission |
| | Type of action | Type 1 |

Technical data

| | | |
|--------------------|--|-----------------------------|
| Safety data | Rated impulse voltage supply / control | 0.8 kV |
| | Pollution degree | 3 |
| | Ambient humidity | Max. 95% RH, non-condensing |
| | Ambient temperature | -30...50°C [-22...122°F] |
| | Storage temperature | -40...80°C [-40...176°F] |
| | Servicing | maintenance-free |
| Weight | Weight | 0.24 kg |

Safety notes

- This device has been designed for use in stationary heating, ventilation and air-conditioning systems and must not be used outside the specified field of application, especially in aircraft or in any other airborne means of transport.
- Outdoor application: only possible in case that no (sea) water, snow, ice, insulation or aggressive gases interfere directly with the device and that it is ensured that the ambient conditions remain within the thresholds according to the data sheet at any time.
- Only authorised specialists may carry out installation. All applicable legal or institutional installation regulations must be complied with during installation.
- Junction boxes must at least correspond with enclosure IP degree of protection!
- The mechanical end stops for limiting the angle of rotation may only be removed for adjustment. They must always be mounted during operation.
- In order to ensure that the IP66 protection can be guaranteed, the device must be mounted with its rear side tightly up against the damper housing.
- In the event the device is installed with a 180° rotation (front side pressed against the damper housing), then only a protection of IP54 is guaranteed.
- The device may only be opened at the manufacturer's site. It does not contain any parts that can be replaced or repaired by the user.
- Cables must not be removed from the device.
- To calculate the torque required, the specifications supplied by the damper manufacturers concerning the cross-section and the design, as well as the installation situation and the ventilation conditions must be observed.
- The device contains electrical and electronic components and must not be disposed of as household refuse. All locally valid regulations and requirements must be observed.

Product features

| | |
|-------------------------------------|---|
| Mode of operation | The actuator is connected with a standard control signal of 0...10 V and drives to the position defined by the control signal. Measuring voltage U serves for the electrical display of the damper position 0...100% and as control signal for other actuators. |
| Simple direct mounting | The actuator is mounted directly on the damper shaft (ø6...12.7 mm) with a universal shaft clamp and then secured with the anti-rotation clip, to prevent it from rotating. The anti-rotation clip Z-ARCM is included in the scope of delivery. |
| Manual override | Manual override with magnet possible (the gear train is disengaged as long as the magnet adheres to the magnet symbol). The magnet for gear train disengagement is integrated in the position indication. |
| Adjustable angle of rotation | Adjustable angle of rotation (max. 95°) with mechanical end stops. |
| High functional reliability | The actuator is overload protected, requires no limit switches and automatically stops when the end stop is reached. |

Product features

Hidden synchronisation If the actuator drives to the lower end stop during ongoing operation, it performs a synchronisation of the control signal at DC 2 V. This ensures that the signal range also corresponds to the effective functional range in ongoing operation. The bottom end stop is actively approached as soon as the control signal is <DC 2.1 V. The actuator drives to the new specified position as soon as the control signal is once again >DC 2.3 V.

Accessories

| Mechanical accessories | Description | Type |
|------------------------|---|--------|
| | Anti-rotation clip, Multipack 20 pcs. | Z-ARCM |
| | Gear train disengagement magnet, Multipack 20 pcs. | Z-MA |
| | Position indicator, Multipack 20 pcs. | Z-PICM |
| | End stop clip, Multipack 20 pcs. | Z-ESCM |
| | Shaft extension 170 mm ø10 mm for damper shaft ø6...16 mm | AV6-20 |

Electrical installation



Supply from isolating transformer.
Parallel connection of other actuators possible. Observe the performance data.

Wire colours:

- 1 = black
- 2 = red
- 3 = white
- 5 = orange

Wiring diagrams

AC/DC 24 V, modulating

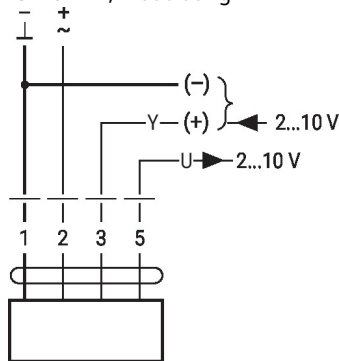

| | | | |
|---|---|------|--|
| 1 | 2 | 3 | |
| | | 2 V | |
| | | 10 V | |



Installation notes



In order to ensure that the IP66 protection can be guaranteed, the device must be mounted with its rear side tightly up against the damper housing.
In the event the device is installed with a 180° rotation (front side pressed against the damper housing), then only a protection of IP54 is guaranteed.

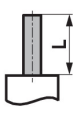

Dimensions

Spindle length

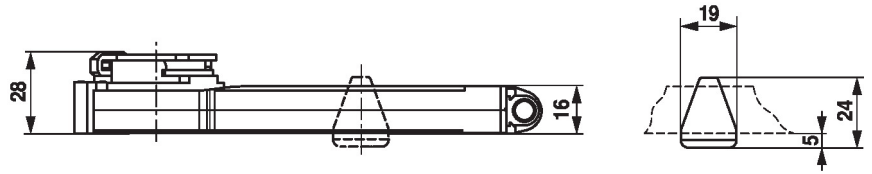
| | | |
|---|---|---------|
|  |  | Min. 32 |
| | | - |



Clamping range

| | | |
|---|---|---|
|  |  |  |
| 6...12.7 | 6 / 8 / 10 | 6...12.7 |

